



Research Update

Briefing for 18 November HSRMC

David Howson, 17th November 2014

Contents:

- Helicopter Health Monitoring
- Helicopter Ditching & Water Impact
- Operations to Moving Helidecks
- Helideck Lighting
- Helicopter Flight Data Monitoring
- GPS – Guided Offshore Approaches
- Helideck Friction
- Helideck Environmental Research
- HUMS for Rotors
- HTAWS
- Lightning Strikes

Helicopter Health Monitoring Research

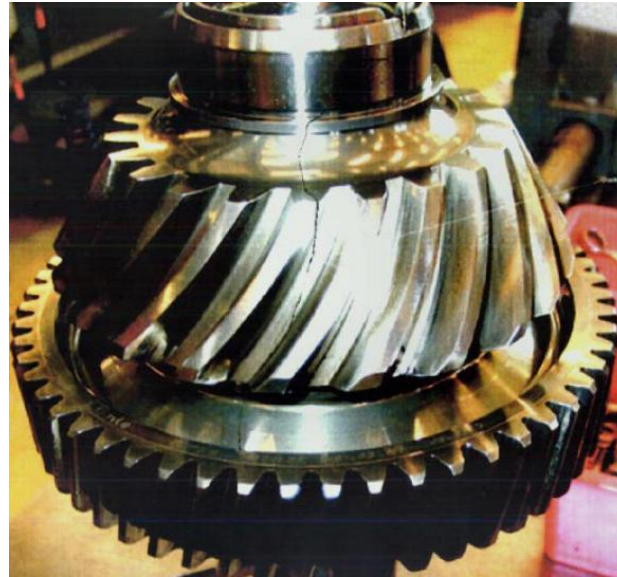
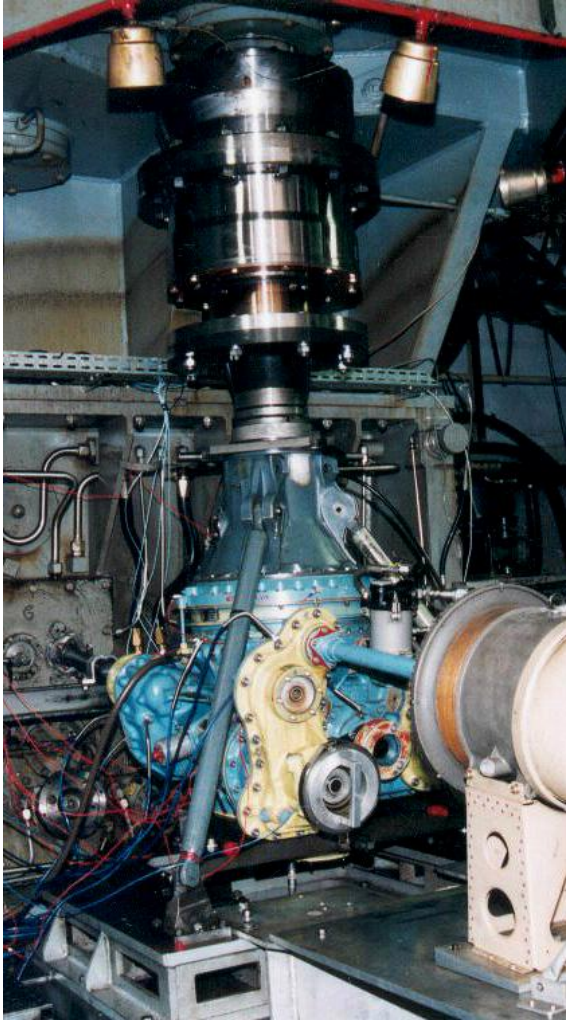

Helicopter Health Monitoring Research



- All HSRMC research completed and reported.
- Implementation of advanced anomaly detection (AAD) needs to be 'encouraged'.
- Update on EASA funded work to follow.

Helicopter Ditching & Water Impact Research



Helicopter Ditching & Water Impact Research – Side-Floating EFS

- 5th EASA RMT.0120 meeting took place at Helitech in Amsterdam during October 2014:
 - Progress slow.
 - NPA delayed to July 2015.
 - Two additional meetings scheduled.
 - Tutorial on proposed new wave tank testing standard to be held in January 2015.
 - Meeting with OEMs to discuss side-floating EFS scheme to be held prior to next meeting.
- No progress in Canada.

Helicopter Ditching & Water Impact Research – EBS

- Two systems (Survitec and Hansen Protection) approved.
- Testing for a third (Viking) about to start.
- Review of EBS training be performed as part of OPITO general review of BOSIET and FOET – CAA is participating.

Operations to Moving Helidecks

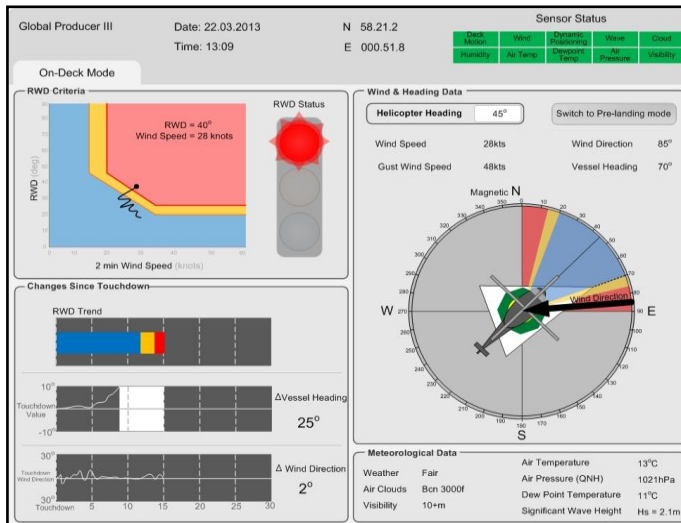
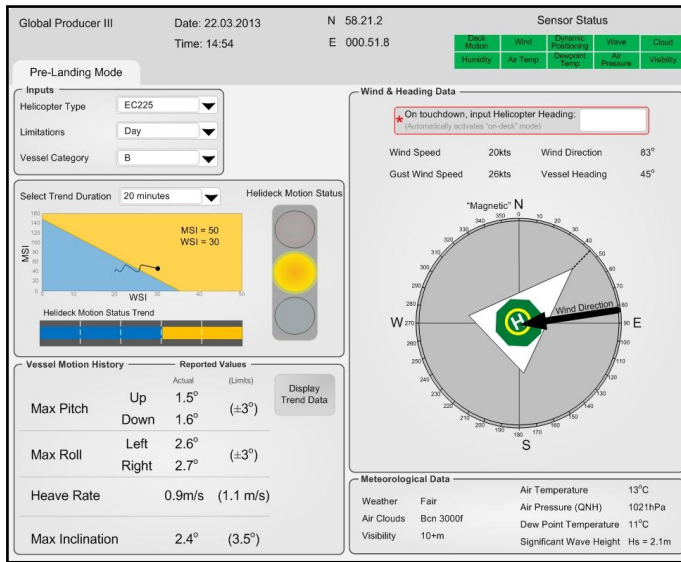

Operations to Moving Helidecks

- Contract for production standard HMS let to Fugro GEOS Ltd.
- HMS will be to CAA/Atkins interim standard:
 - Improved, standardised displays;
 - Deck-mounted traffic lights;
 - Relative wind monitoring;
 - Significant heave rate (SHR) with anti-flicker;
 - Generic advisory only MSI/WSI limit.
- Trials on Captain FPSO (Chevron/Bristow) due to commence January 2015.
- CAA/Atkins/Fugro launch meeting on 26 Nov.

Helideck Lighting



Helideck Lighting – Circle and H

- Update to CAP 437 appendix C finalised:
 - Tolerances on location of circle & 'H' on helideck introduced;
 - Tolerances on circle & 'H' introduced.
- Some problems with Orga system on Centrica CPC-1 due to installation method chosen.
- 2nd Orga trials system installed on BP Miller platform in September 2014.
- Implementation:
 - Most orders are to ship yards for new decks;
 - North Sea slow to start retrofit;
 - Some platform operators understood to be considering not fitting the system and ceasing night flights – issue of emergency de-manning.

Helideck Lighting - Other

- Specification for heli hoist light being finalised.
- Issues with resetting of wave-off lights on NUIs being discussed with industry.

Helicopter Flight Data Monitoring

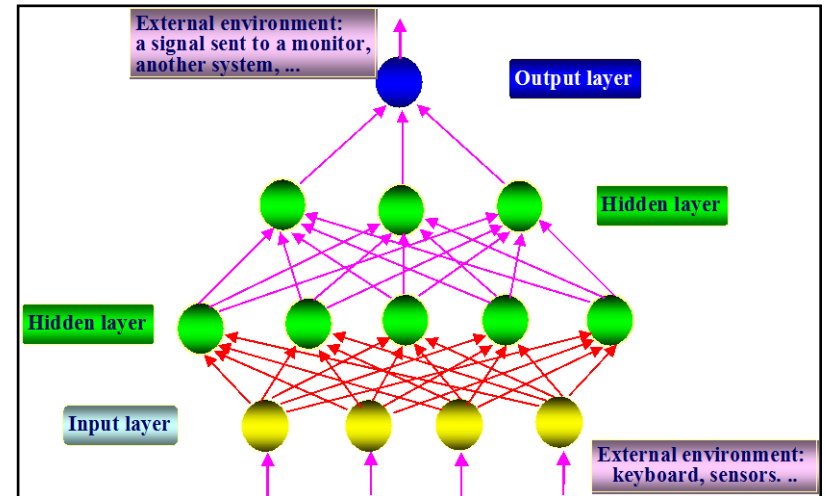
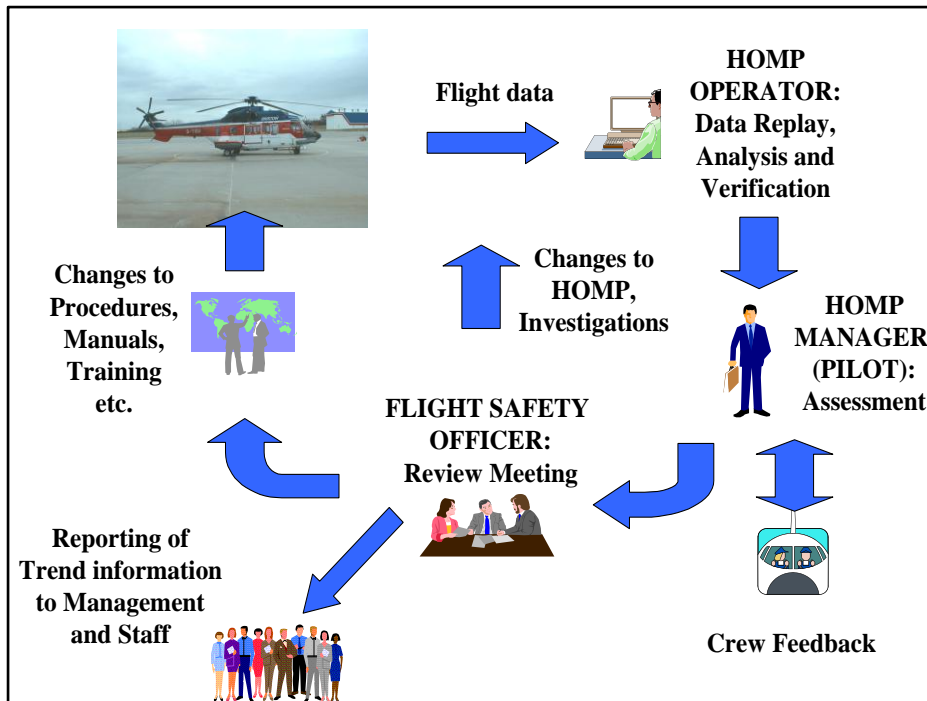

Helicopter Flight Data Monitoring

- No progress on July helicopter FDM User Group since last meeting in June 2014.
- Agreed exercise to review event sets for EC225 to attempt to consolidate understanding.
- Insufficient resource within helicopter operators?
- Need joint industry effort to raise standards?

GPS- Guided Offshore Approaches

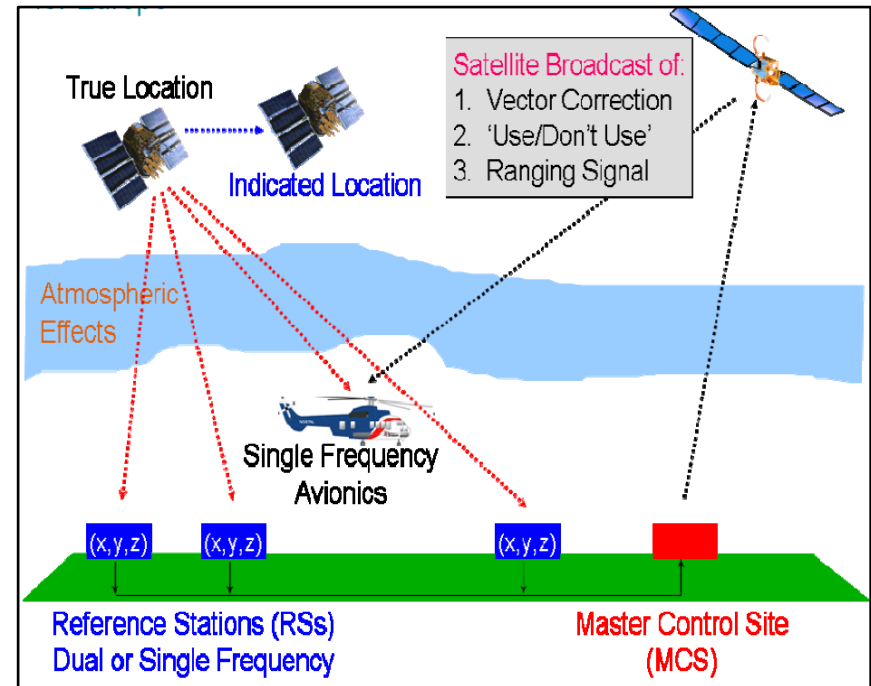

GPS- Guided Offshore Approaches

- New helideck lighting now on Miller platform and EC225 operating restriction lifted so Bond AS332L2 trials aircraft availability should be ok. Night trial could now be progressed.
- Introduction into service trials:
 - Could progress in parallel with night trial;
 - Could use existing OEM system – close enough to SOAP but will need AIS to be added (EFIS software modification);
 - Initial discussions held with JOR;
 - Need to progress with JOR/HeliOffshore.

Helideck Friction

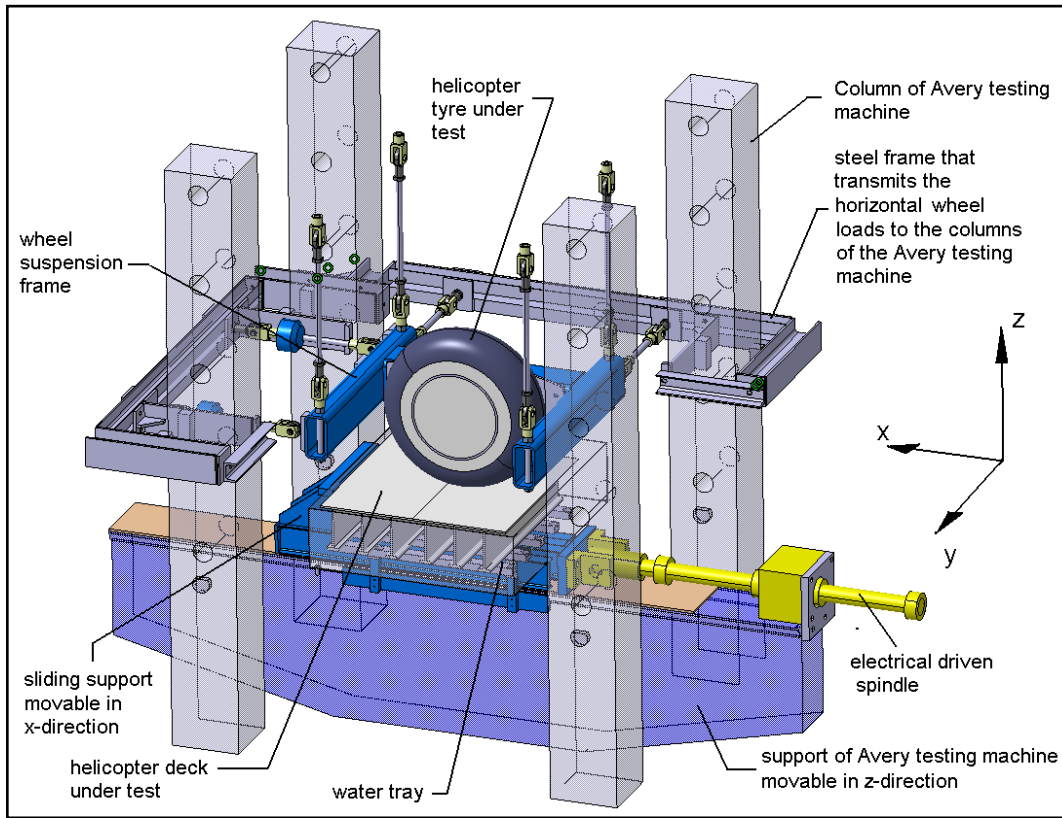

Helideck Friction

- All research at NLR in The Netherlands completed and reported.
- Proposed new scheme discussed and agreed in principle with HCA Helideck Steering Committee (HSC).
- CAA to produce scheme detail for discussion and agreement with HCA HSC prior to wider industry consultation.
- New scheme to be implemented in CAP 437, backed up by detail published in separate report.

Helideck Environmental Research

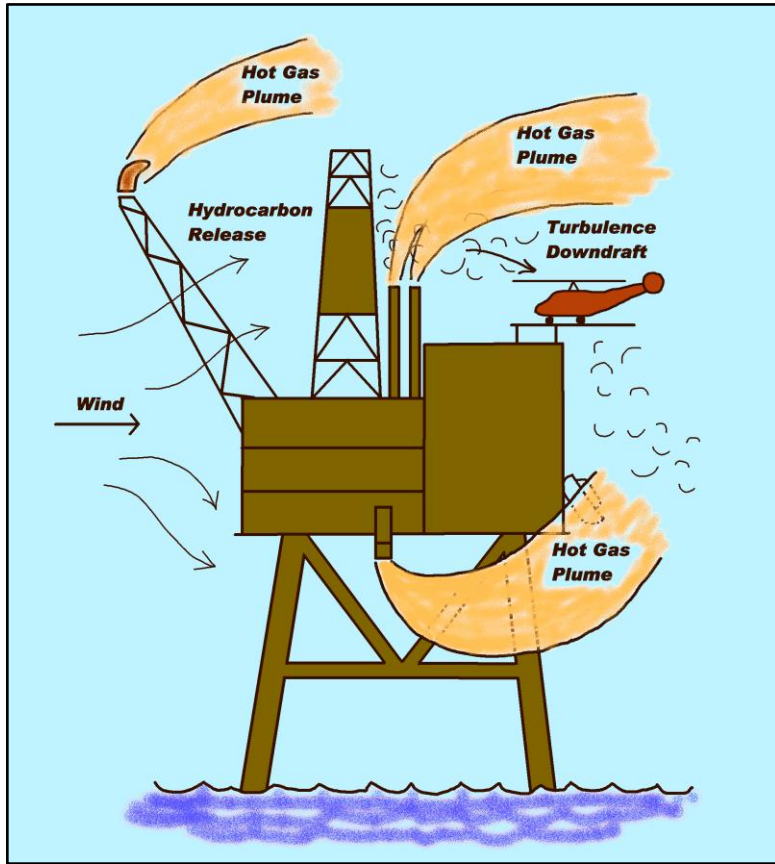

Helideck Environmental Research

- Turbine exhausts on Ninians have/are being re-routed following issue of Sikorsky Safety Advisory.
- Use of FDM to map and monitor helideck environments will be promoted at the HFDM User Group.
- Presentation from Norway on turbine plumes to follow.
- Note five Safety Recommendations issued by NTSB regarding release of 'raw gas'.

HUMS for Rotors

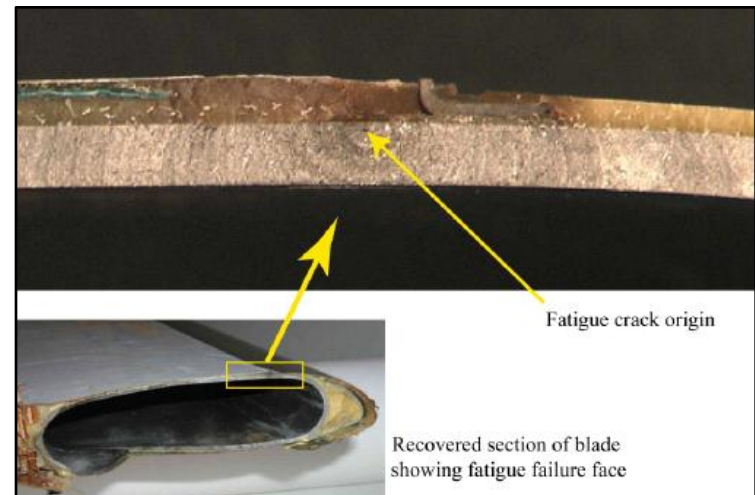
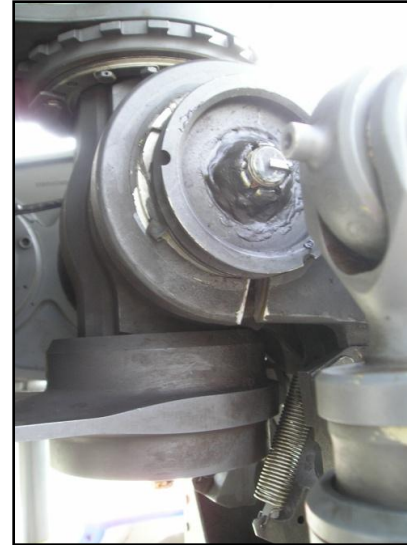

HUMS for Rotors

- Update from Alan Wilson, AgustaWestland.

Helicopter TAWS

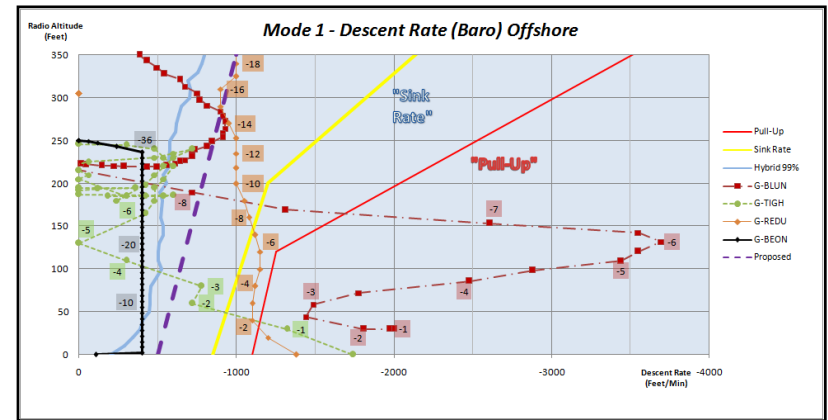
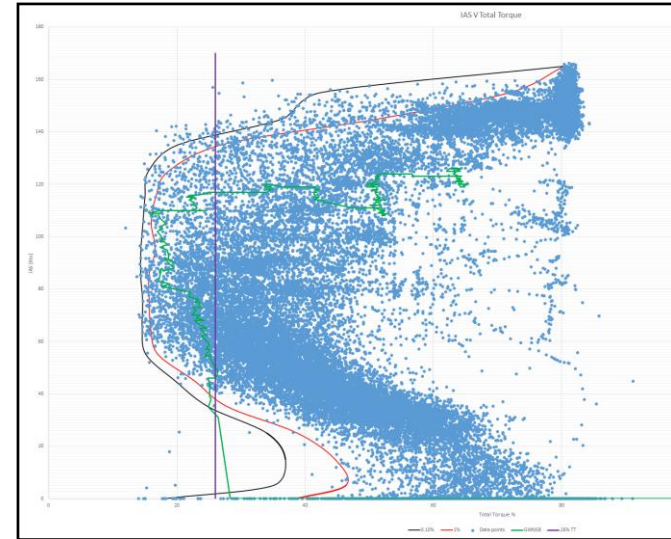
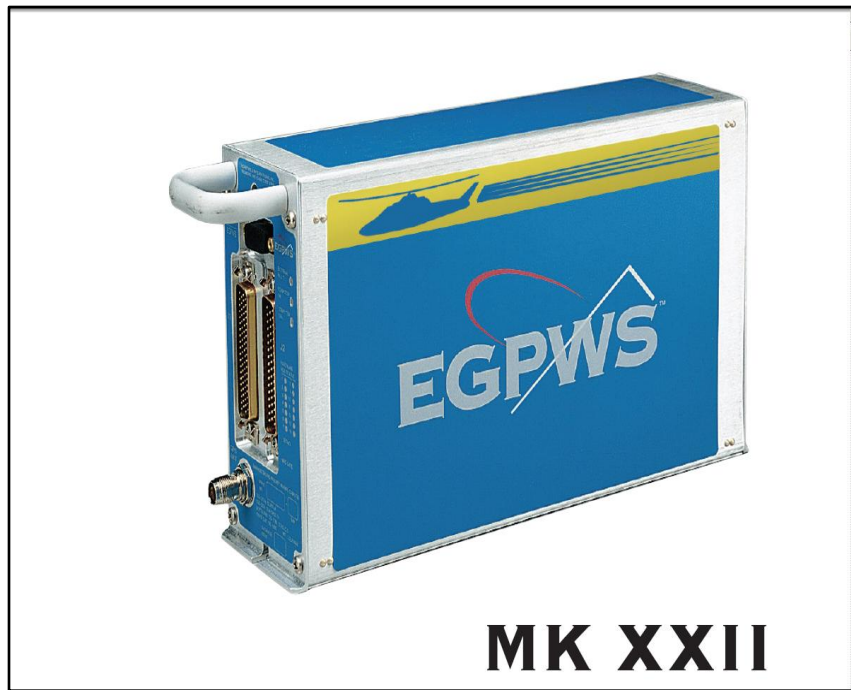

Helicopter TAWS

- Contract with Flightdatapeople.com extended to investigate further envelopes to address G-WNSB accident scenario.
- Last meeting held on 01 October 2014:
 - Improved Mode 1 to 6 envelopes increased warning time from 5.7 sec to approx 8 sec, but too late to help;
 - New collective pitch vs airspeed envelope showing good promise giving approx 12.5 sec;
 - Alternative energy-based warning envelope also being investigated.
- Work on warning forms/formats:
 - Specification agreed;
 - Some funding secured but will likely need more; plan to approach HeliOffshore.

Lightning Strikes

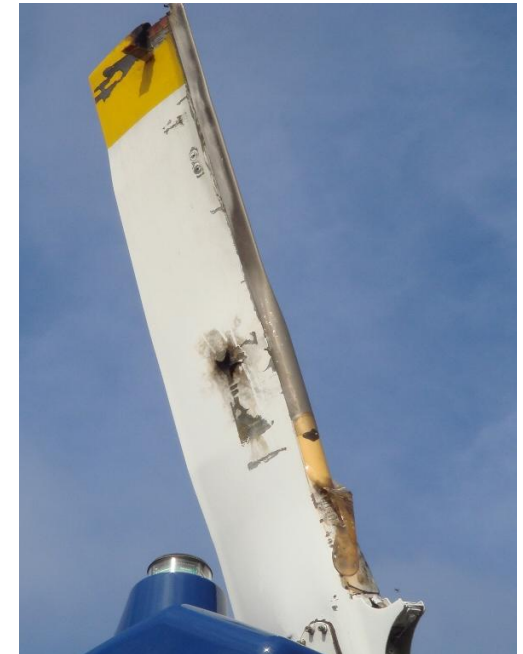
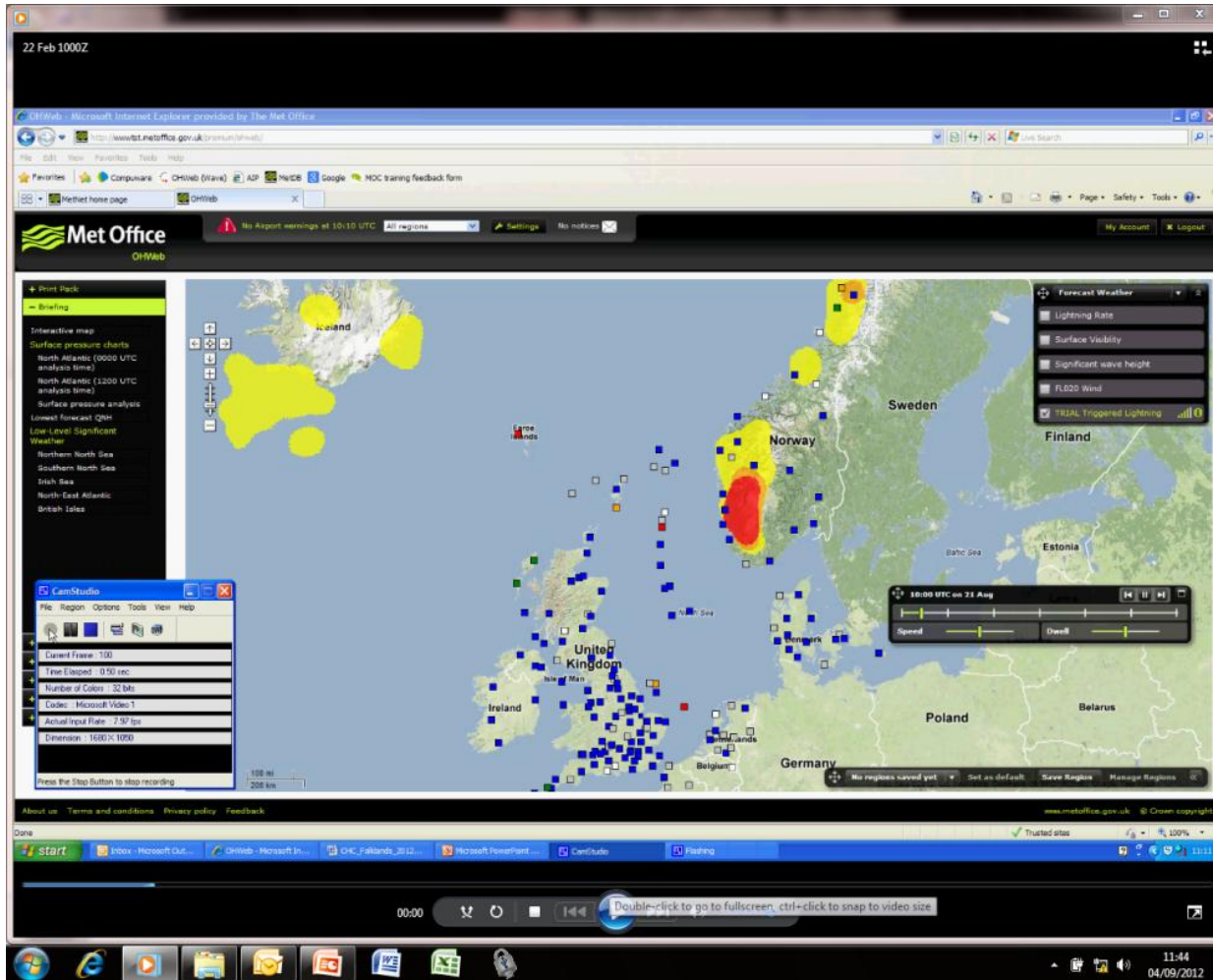

Lightning Strikes

- Winter 2013/14 trial inconclusive due to very low incidence of lightning risk.
- Issue of display volatility reported believed to be due to volatility of risk – has been addressed by adding advisory to F215.
- Further trial during winter 2014/15 underway.
- Precipitation radar coverage to be extended under EUMETNET OPERA project – should improve accuracy of forecasts for Norway and Scatsta.

Thank you for your attention...

Any questions?